

USB Adapter for Switch

Instruction Manual

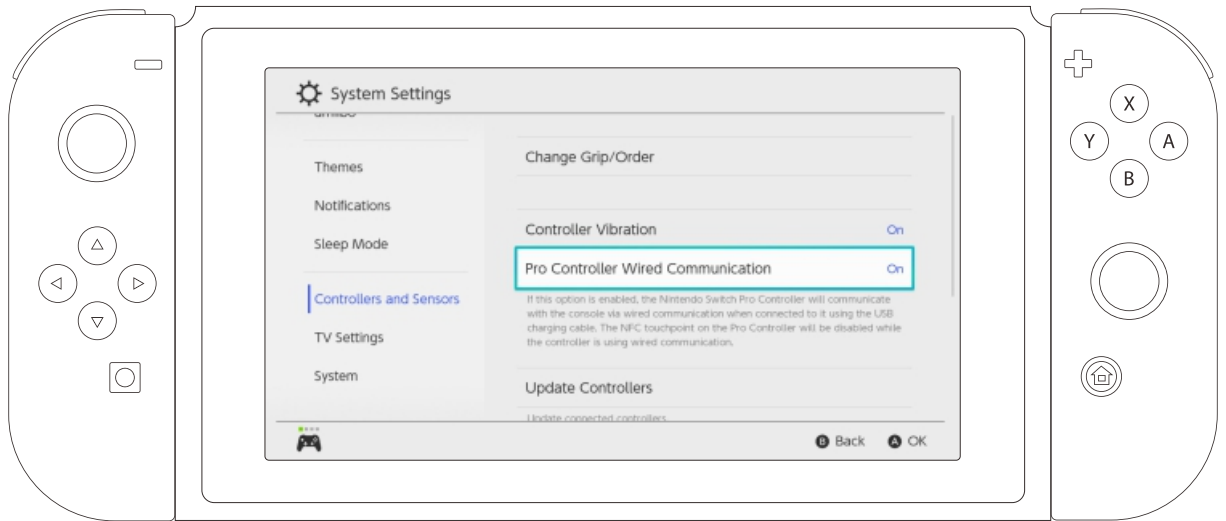

Make sure "Pro Controller Wired Communication" is On.
* above V3.0

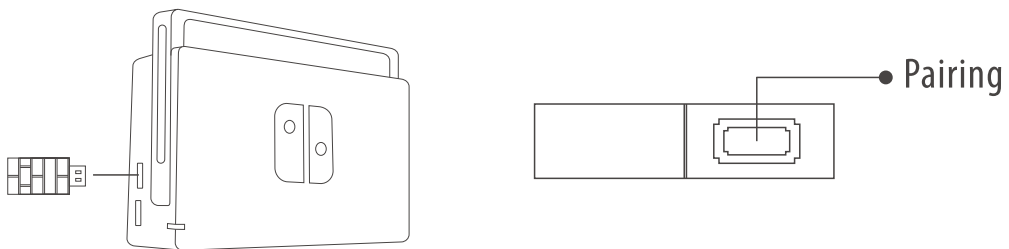

8Bitdo USB Wireless Adapter Functionality Chart

Mode Controller	Switch			Xinput			Dinput			Mac		
	Basic functionality	Vibration	Motion controls	Basic functionality	Vibration	Motion controls	Basic functionality	Vibration	Motion controls	Basic functionality	Vibration	Motion controls
PS4	✓	✓	✓	✓	✓		✓			✓		
SN30 Pro SF30 Pro	✓			✓	✓		✓			✓		
Other 8Bitdo controllers	✓			✓			✓			✓		
PS3	✓			✓			✓			✓		
Wii Mote	✓			✓			✓			✓		
Wii U Pro	✓			✓			✓			✓		

Quick change mode:

1. Connect your controller to the USB Adapter. Your controller may need to be reconnected after switching mode.

Switch: Automatic.

X-Input: press and hold SELECT+UP for 3 seconds.

D-Input: press and hold SELECT+LEFT for 3 seconds.

macOS: press and hold SELECT+RIGHT for 3 seconds.

For PS4 controller

1. Insert USB Adapter into console and then press the pairing button (the LED will rapidly blink)
 2. Press and hold the PS and Share buttons until the lightbar begins to strobe quickly in double.
 3. Wait until your USB Adapter's LED is solid blue and the controller's lightbar stay on.
 4. For next connection only need to press PS button and wait until receiver's LED is solid blue.
- * Key command for switching between two levels: L+R+SELECT

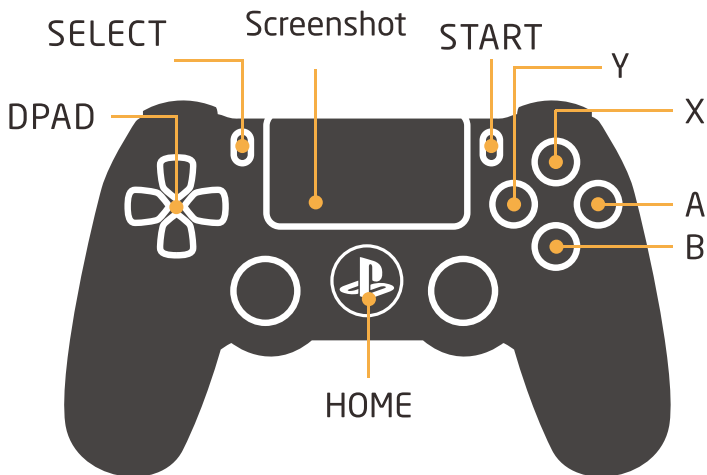

For Xbox One S/X Bluetooth controller

1. Insert USB Adapter into console and then press the pairing button (the LED will rapidly blink).
 2. Press HOME button to turn on your Xbox One S/X Bluetooth controller and then press bind button.
 3. Wait until both LEDs on the USB Adapter and controller stay solid.
 4. USB adapter will auto-reconnect to the controller when you turn back on the controller with the HOME button only.
- * Vibration is supported on Switch and X-input mode.

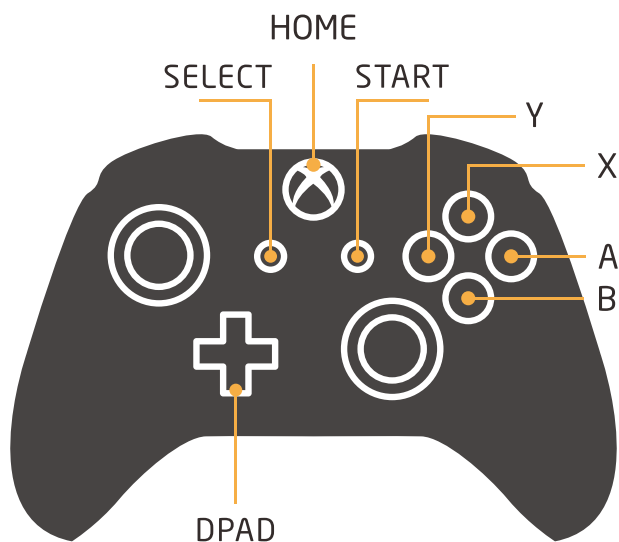

For Wii U Pro controller

1. Insert USB Adapter into console and then press the pairing button (the LED will rapidly blink).
2. Press your Wii U Pro controller's sync button.
3. Wait until your USB Adapter's LED is solid blue and the controller's #1 LED stay on.
4. For next connection only need to press A button.

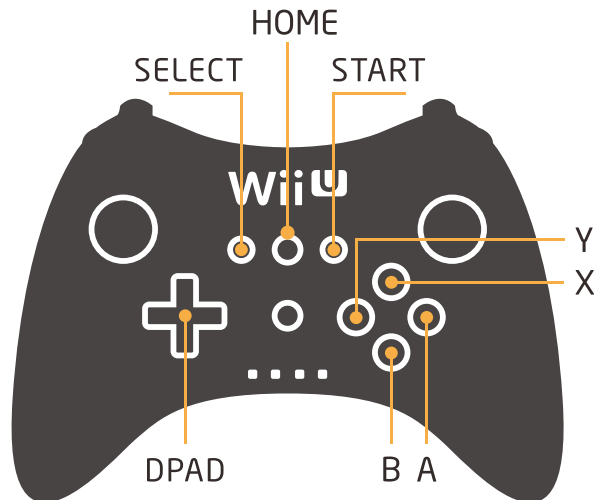

For PS3 controller

1. Download and Run 8Bitdo USB Adapter Tools on your PC available for Mac and PC.
2. On your USB Adapter, hold down the pairing button and connect it to your MAC/PC via USB.
3. Connect your PS3 controller to MAC/PC via USB.
4. Once your USB Adapter and PS3 controller are both connected via USB, click the "Pair" button in the software.
5. Once pairing is complete, you can insert your USB Adapter into your console.
6. Now press the PS button on your PS3 controller.
7. Wait until your USB Adapter's LED is solid blue and the controller's #1 LED stay on.
8. To re-sync after powering your console down, begin from step 6.

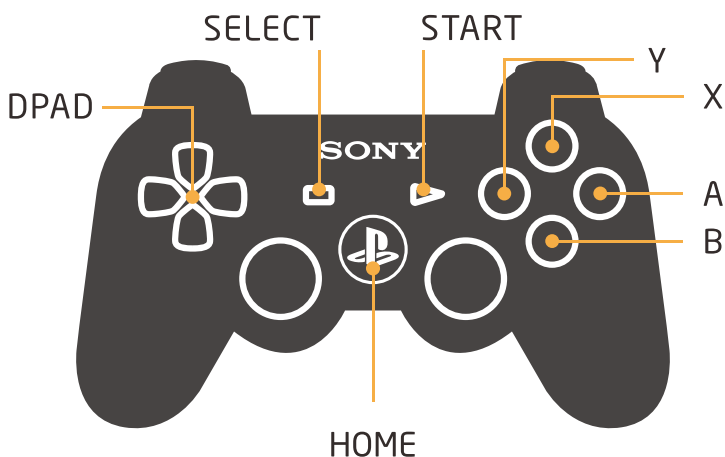

For Wii Remote/Wii MotionPlus controller

1. Insert USB Adapter into console and then press the pairing button (the LED will rapidly blink).
2. Press the Wii Remote/Wii MotionPlus controller's sync button.
3. Wait until your USB Adapter's LED is solid blue and the controller's #1 LED stay on.
4. To re-sync after powering your console down.

For Wii Remote: press 1 and 2 buttons.

For Wii MotionPlus: press A button.

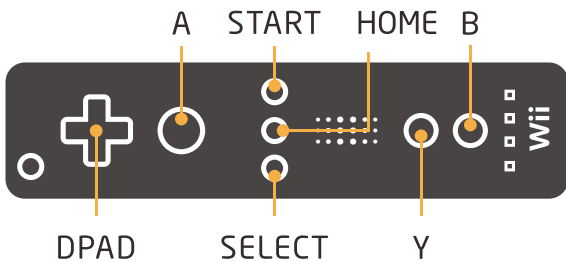

For 8Bitdo controllers

SN30 Pro/SF30 Pro:

1. Press START+B to turn on your SN30 Pro/SF30 Pro controller.
2. Press both PAIR buttons on the receiver and controller to sync them.
3. Both LEDs on the receiver and controller will become solid when they are successfully paired.

N30 Pro/F30 Pro:

1. Press POWER to turn on your controller.
2. Press both PAIR buttons on the receiver and controller to sync them.
3. Both LEDs on the receiver and controller will become solid when they are successfully paired.

N30/F30/SN30/SF30/Zero:

1. Press START to turn on your controller.
2. Press both PAIR button on the receiver and SELECT on the controller to sync them.
3. Both LEDs on the receiver and controller will become solid when they are successfully paired.

N30 Arcade Stick:

1. Press HOME to turn on your arcade stick.
2. Press both PAIR button on the receiver and arcade stick to sync them.
3. Both LEDs on the receiver and controller will become solid when they are successfully paired.

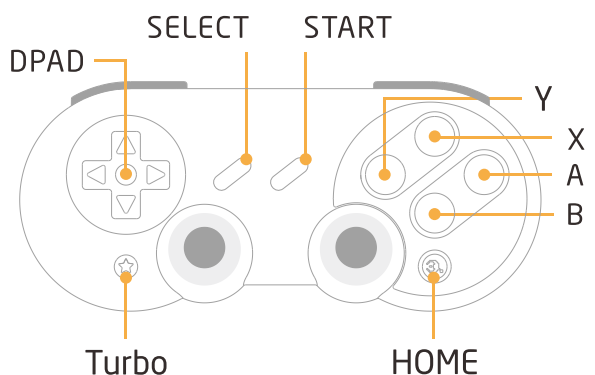
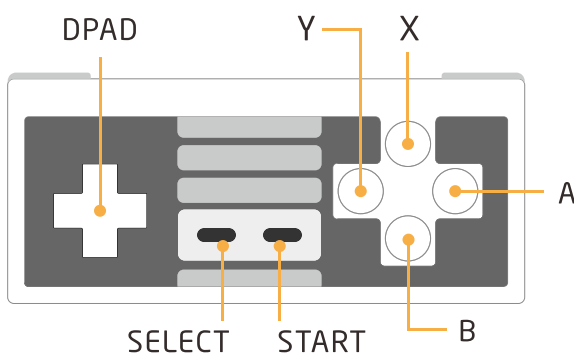

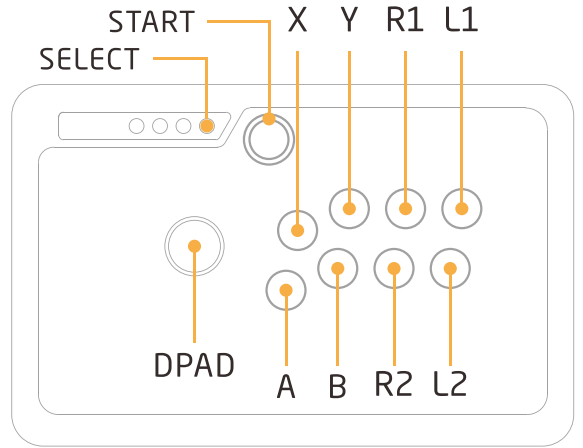
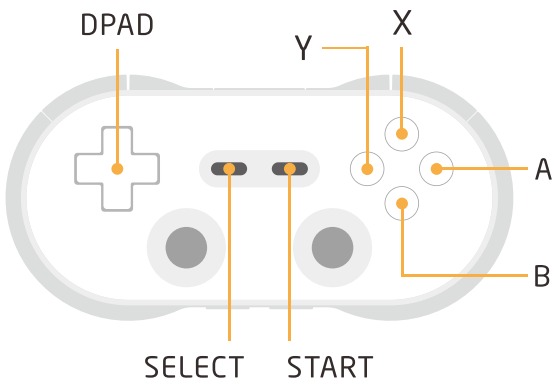
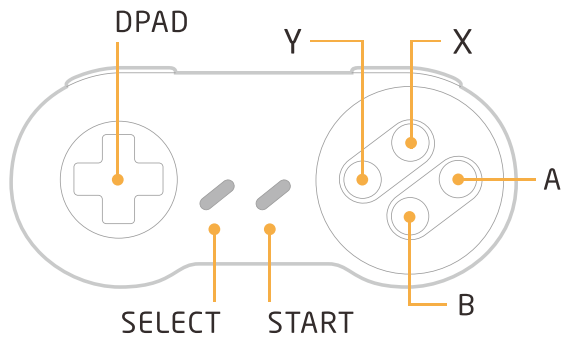
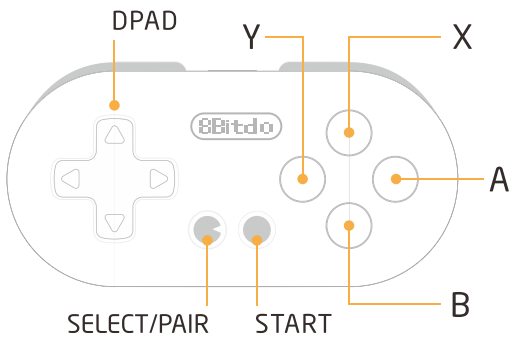

USB Adapter for X- input

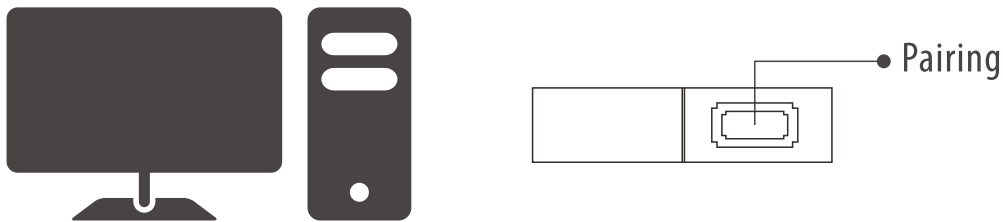

For PS4 controller

1. Insert USB Adapter into console and then press the pairing button (the LED will rapidly blink)
 2. Press and hold the PS and Share buttons until the lightbar begins to strobe quickly in double.
 3. Wait until your Retro Receiver's LED is solid blue and the controller's lightbar stay on.
 4. For next connection only need to press PS button and wait until receiver's LED is solid blue.
- * Key command for switching between two levels: L+R+SELECT

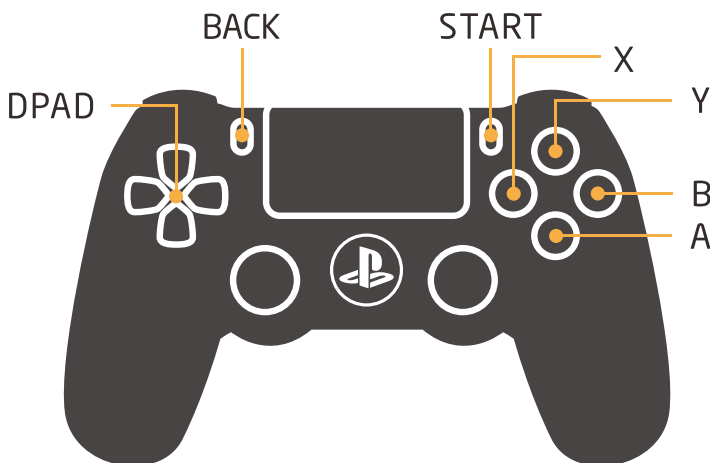

For PS3 controller

1. Download and Run 8Bitdo USB Adapter Tools on your PC available for Mac and PC.
2. On your Retro Receiver, hold down the pairing button and connect it to your MAC/PC via USB.
3. Connect your PS3 controller to MAC/PC via USB.
4. Once your Retro Receiver and PS3 controller are both connected via USB, click the "Pair" button in the software.
5. Once pairing is complete, you can insert your Retro Receiver into your console.
6. Now press the PS button on your PS3 controller.
7. Wait until your Retro Receiver's LED is solid blue and the controller's #1 LED stay on.
8. To re-sync after powering your console down, begin from step 6.

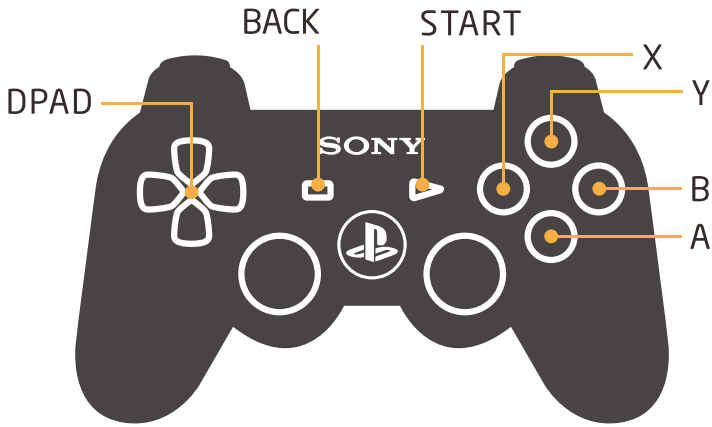

For Wii Remote/Wii MotionPlus controller

1. Insert USB Adapter into console and then press the pairing button (the LED will rapidly blink)
2. Press the Wii Remote/Wii MotionPlus controller's sync button.
3. Wait until your Retro Receiver's LED is solid blue and the controller's #1 LED stay on.
4. To re-sync after powering your console down.

For Wii Remote: press 1 and 2 buttons.

For Wii MotionPlus: press A button.

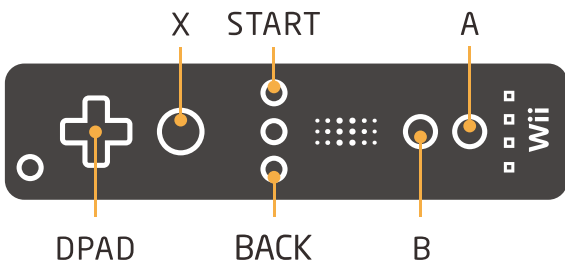

For Wii U Pro controller

1. Insert USB Adapter into console and then press the pairing button (the LED will rapidly blink).
2. Press your Wii U Pro controller's sync button.
3. Wait until your Retro Receiver's LED is solid blue and the controller's #1 LED stay on.
4. For next connection only need to press A button.

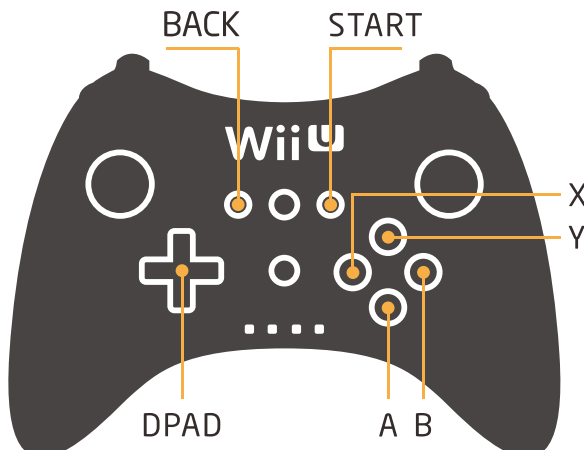

For 8Bitdo controllers

SN30 Pro/SF30 Pro:

1. Press START+B to turn on your SN30 Pro/SF30 Pro controller.
2. Press both PAIR buttons on the receiver and controller to sync them.
3. Both LEDs on the receiver and controller will become solid when they are successfully paired.

N30 Pro/F30 Pro:

1. Press POWER to turn on your controller.
2. Press both PAIR buttons on the receiver and controller to sync them.
3. Both LEDs on the receiver and controller will become solid when they are successfully paired.

N30/F30/SN30/SF30/Zero:

1. Press START to turn on your controller.
2. Press both PAIR button on the receiver and SELECT on the controller to sync them.
3. Both LEDs on the receiver and controller will become solid when they are successfully paired.

N30 Arcade Stick:

1. Press HOME to turn on your arcade stick.
2. Press both PAIR button on the receiver and arcade stick to sync them.
3. Both LEDs on the receiver and controller will become solid when they are successfully paired.

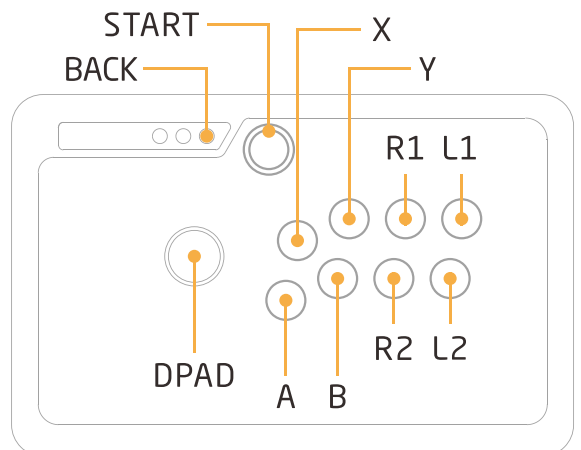
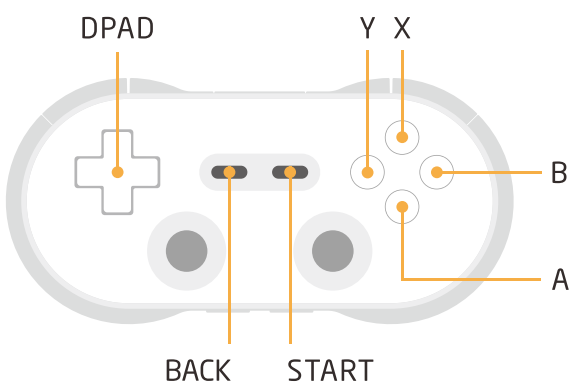
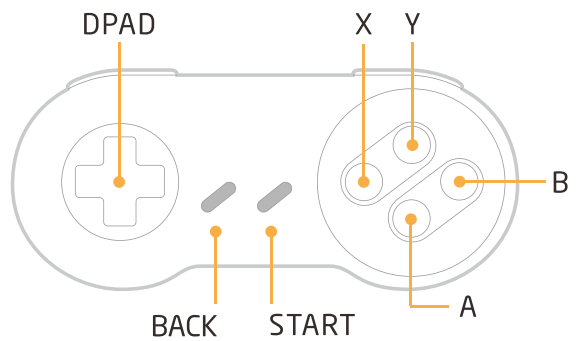
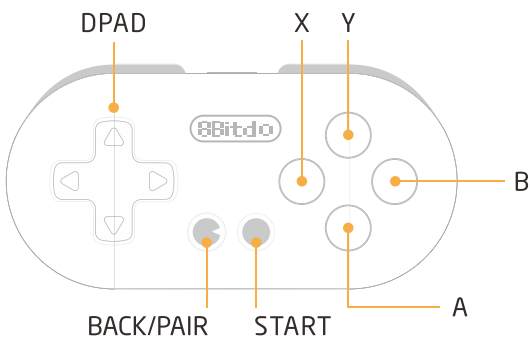

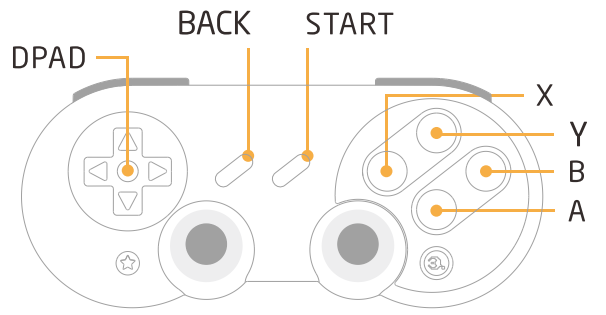
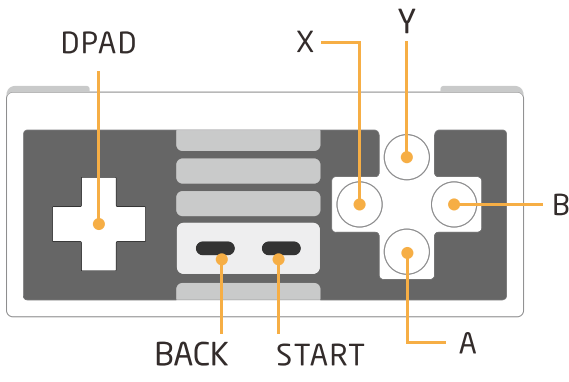

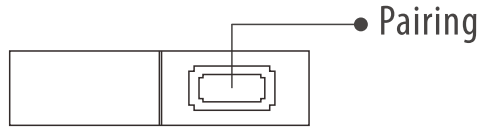

For 8Bitdo controllers

SN30 Pro/SF30 Pro:

1. Press START+B to turn on your SN30 Pro/SF30 Pro controller.
2. Press both PAIR buttons on the receiver and controller to sync them.
3. Both LEDs on the receiver and controller will become solid when they are successfully paired.

N30 Pro/F30 Pro:

1. Press POWER to turn on your controller.
2. Press both PAIR buttons on the receiver and controller to sync them.
3. Both LEDs on the receiver and controller will become solid when they are successfully paired.

N30/F30/SN30/SF30/Zero:

1. Press START to turn on your controller.
2. Press both PAIR button on the receiver and SELECT on the controller to sync them.
3. Both LEDs on the receiver and controller will become solid when they are successfully paired.

N30 Arcade Stick:

1. Press HOME to turn on your arcade stick.
2. Press both PAIR button on the receiver and arcade stick to sync them.
3. Both LEDs on the receiver and controller will become solid when they are successfully paired.

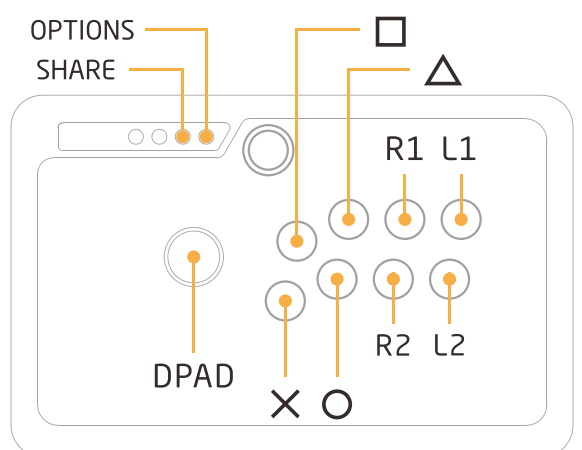
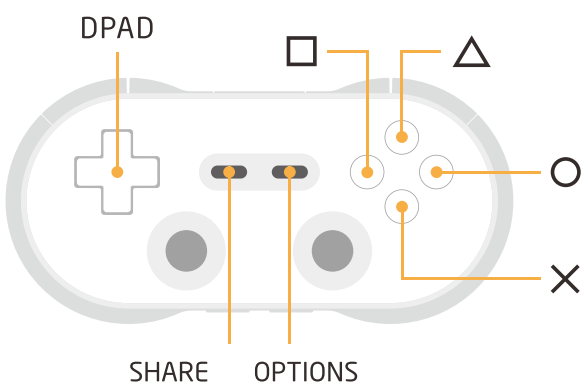
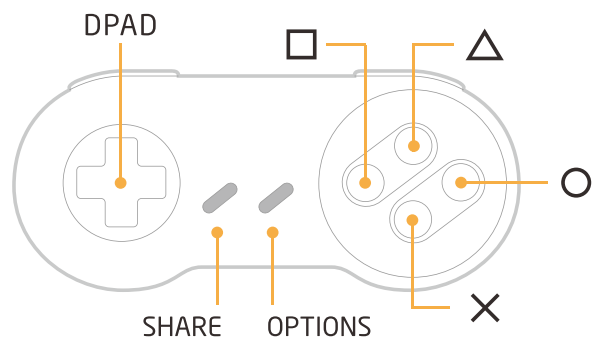
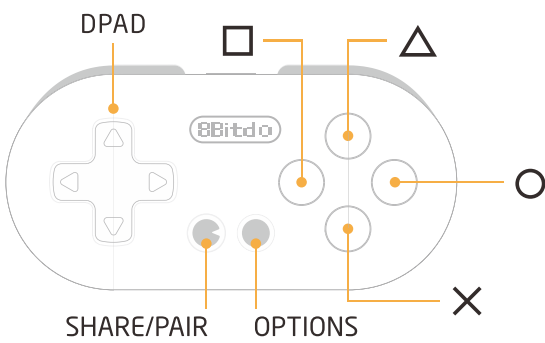

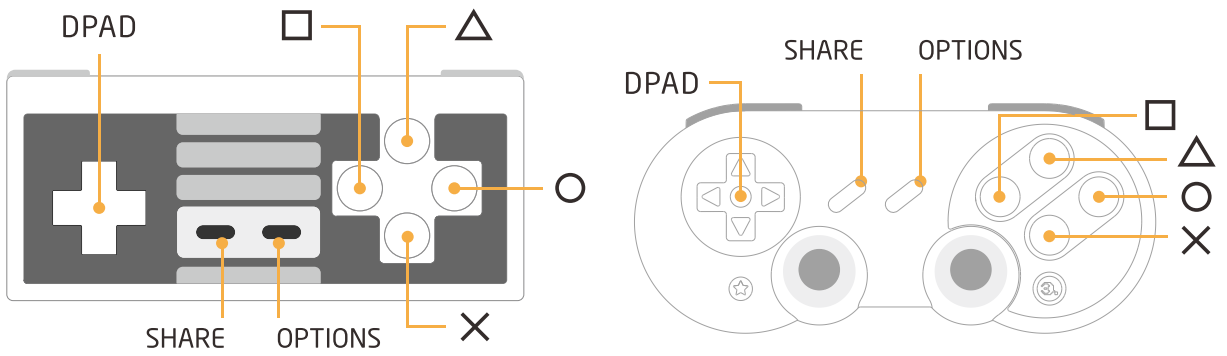

For Wii Remote/Wii MotionPlus controller

1. Insert USB Adapter into console and then press the pairing button (the LED will rapidly blink)
2. Press the Wii Remote/Wii MotionPlus controller's sync button.
3. Wait until your Retro Receiver's LED is solid blue and the controller's #1 LED stay on.
4. To re-sync after powering your console down.

For Wii Remote: press 1 and 2 buttons.

For Wii MotionPlus: press A button.

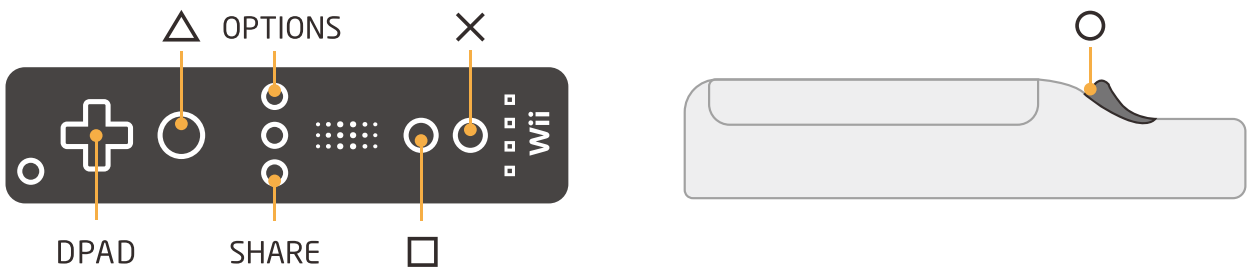

For Wii U Pro controller

1. Insert USB Adapter into console and then press the pairing button (the LED will rapidly blink).
2. Press your Wii U Pro controller's sync button.
3. Wait until your Retro Receiver's LED is solid blue and the controller's #1 LED stay on.
4. For next connection only need to press A button.

